

# LE GEMME NOTTE



**LE FABLIER**

valori *per* sempre





**LE FABLIER**

*Valori per sempre*



La bellezza  
non rende felice  
colui che la possiede,  
ma colui  
che la può  
amare e desiderare.

*Beauty  
does not make happy  
whoever owns  
but one who can love  
and desire it.*



# Custodi della tradizione

**La scelta del legno** Forte, generoso, ricco di storia e di tradizione. Niente è più prezioso, e più caldo, del legno. La collezione "Le Gemme" nasce da questo calore, dalla solidità delle tavole che gli specialisti Le Fablier selezionano con cura ed esperienza. Per scegliere solo le essenze più pregiate, per verificarne il taglio migliore, per controllare la perfetta stagionatura. Nel pieno rispetto della natura e della bellezza delle essenze tradizionali.

**Le lavorazioni** Di maestro in maestro, di generazione in generazione, la nobile arte del legno trova in Le Fablier un appassionato custode. Erede di questa antica arte, ne rispetta i segreti e i dettami, perché ogni lavorazione venga eseguita solo secondo la migliore tradizione d'origine. Dall'incastro a coda di rondine all'intelaiatura di schiene e cassetti, dai rilievi in legno massiccio ai particolari rifiniti a mano. Un'arte che nasce dal tempo per sfidarlo, e per rimanere per sempre impressa nella memoria di chi la possiede con la stessa forza e lo stesso calore del fuoco. Proprio come il marchio a fuoco che sigla e distingue ogni singolo pezzo Le Fablier.

**I segreti** Pensieri, ricordi, sensazioni. Ci sono cose che è bello ritrovare e proteggere. Cose che non amano imporsi, ma preferiscono restare serbate in luoghi creati per mantenerne il fascino. Cassetti a scomparsa, piccoli angoli nascosti, vani inattesi. I mobili Le Fablier celano i loro segreti, custodi di amuleti misteriosi raccolti in viaggi di terre lontane. Perché chi possiede quei mobili, possa trasformarli in emozioni.

**Le finiture** La più alta perfezione è nei particolari, la bellezza più completa è nei dettagli. Soprattutto in un mobile che deve saperci parlare di eleganza, ogni giorno. Ecco perché dai rilievi più ricercati agli intrecci più pregiati, ogni piccola finitura dei mobili Le Fablier viene studiata per verificarne l'esatta coerenza stilistica, le uniformità di stile, e l'omogeneità di ispirazione tra il dettaglio e il suo contesto d'origine. E quello che il tempo ci restituisce è solo realtà.

**La lucidatura** La bellezza non è mai soltanto fatta di sguardi. È nei profumi, nelle sensazioni, nel piacere tattile di superfici da sfiorare. Per questo, la bellezza di ogni mobile Le Fablier viene completata da un antico rito: la lucidatura eseguita seguendo la più rigorosa tradizione, che si conclude con la stesura manuale della cera vergine d'api. Un fascino caldo e brillante che l'esperto lucidatore sa esaltare, e che può essere rinnovato ogni giorno con un semplice panno di lana. Natura, tradizione, cultura. E il legno migliore, quasi avesse imprigionata dentro di sé la luce del sole, sembra, d'improvviso restituirla.

**La ricerca stilistica** Ogni mobile Le Fablier ha come più grande amico il tempo. Per questo ama conoscerlo e rispettarlo e custodirne la storia. Per questo ogni creazione nasce solo da disegni e progetti che seguono precisi riferimenti delle più importanti tradizioni stilistiche dei paesi d'origine. Esperti disegnatori, guidano i migliori falegnami nella realizzazione degli arredi che dovranno saper intendere e prevedere le esigenze di una casa in continua evoluzione. "Le Gemme" nasce per offrire la soluzione più consona e personalizzata a chi ama vivere nella propria casa in un armonioso equilibrio di bellezza e funzionalità. Ogni momento del passato in cui l'uomo, guardando alla natura, ha ritrovato equilibrio, gusto serenità e poesia, diventa la nostra ispirazione e la nostra vocazione. Per ritrovare il fascino di atmosfere calde e raffinate, con le arti e i segreti del più antico artigianato. Per continuare a emozionare chi, quando sceglie di abitare lo stile, sa che il solo sentiero da imboccare è quello del ritorno.



# Guardians of tradition

**The choice of the wood** Strong, generous, rich in history and tradition. Nothing is finer or warmer than wood. The 'Le Gemme' collection comes out of this warmth and the solidity of the wood boards that Le Fablier's professionals have carefully and expertly selected. They choose the finest woods, ensure the best cut and check for optimal seasoning. All with complete respect for the nature and beauty of traditional woods.

**Crafting** Throughout the generations, from master to master, the noble art of woodworking has found a devoted guardian in Le Fablier. As the heir of this ancient art, it respects its secrets and principles to craft each piece exclusively in keeping with the finest and oldest traditions, from dovetail joints to the framing of backs and drawers, from the profiled details in solid wood to the hand-finished carving. These pieces of art come out of history to become timeless and be emblazoned in the minds of their owners with the very strength and heat of fire. Just like the firebrand that marks and distinguishes every single Le Fablier piece.

**The secrets** Thoughts, memories and feelings. There are some things that it is good to recover and protect. These things do not like to assert themselves, preferring to stay stored in places created to preserve their wonder. Concealed drawers, hidden little corners, unexpected compartments. Le Fablier's furniture pieces hide their secrets like faithful guardians of mysterious charms found in remote lands. And the owners of these pieces can turn these moments into the emotions they hold.

**The finishing details** The highest perfection is in the specifics. The most complete beauty is in the details. Especially in a piece of furniture that must express the grace and elegance every day of the year. This is why every last finishing detail of Le Fablier furniture, from the most elegant profiled details to the most precious weaving, is designed to ensure its absolute historic accuracy, uniformity of style and match the inspiration of every detail with its original context. What time returns to us is simply reality.

**Polishing** Beauty is never just what you see with your eyes. It is the scents, the feelings and the tactile pleasure of the surfaces to be caressed. This is why the beauty of each Le Fablier piece is completed by an old ritual: polishing executed following the most rigorous traditional methods and completed with a manual application of pure beeswax. The master polisher knows how to exalt this warm, shining beauty that can be renewed every day with a simple wool cloth. Nature, tradition and culture. It is as if the finest wood had captured the light of the sun inside itself and suddenly decides to let it out.

**Stylistic research** Every Le Fablier piece's best friend is time. This means that it wants to know time, respect it and guard its stories. This is why each creation is born exclusively of designs that keep to specific references from the most important stylistic traditions of the countries of origin. Master designers guide the best carpenters in creating furniture that must be able to understand and anticipate the needs of homes that are always adapting. The 'Le Gemme' collection is intended to offer the perfect, customized solution for those who wish to live in their homes amidst a harmonious balance of beauty, functionality and exotic feeling. Every moment in history in which someone has looked to nature to find balance, taste, serenity and poetry has become our inspiration and our vocation to rediscover the beauty of warm atmospheres with the secrets and the arts of the most ancient craftsmanship. And to continue to move those who choose to live in a style and know that the only path to take is the one back.





157 Corallo - Letto 168 x 218 x 109

115 Topazio - Comò 122 x 54 x 105

112 Zaffiro - Comodino 54 x 35 x 66

GLAM - Lampada 25 x 13 x 40 - Lampada da terra 43 x 23 x 165







116 Corallo - Letto 168 x 220 x 109  
117 Zircone - Comodino 52 x 36 x 68  
MISS - Lampada Ø 22 x h.42  
HARI - Lampada Ø 50 x h.180



113 Ambra - Specchiera 72 x 3 x 92

115 Topazio - Comò 122 x 54 x 105

10 HARI - Lampada coll. Luci e Forme Ø 35 x h.59





112 Zaffiro - Comodino 54 x 35 x 66

12 MISS - Lampada coll. Luci e Forme Ø 22 x h.42



Nulla  
è più prezioso  
del tempo  
poichè è il prezzo  
dell'eternità

*Nothing  
is more precious  
time as it is  
the price of eternity.*



160 Aurea - Scrivania 140 x 70 x 80  
MISS - Lampada coll. Luci e Forme Ø 22 x h.42 GLAM  
- Lampada coll. Luci e Forme 25 x 13 x 40



156 Granato - Letto 168 x 220 x 109  
117 Zircone - Comodino 52 x 36 x 68  
MISS - Lampada Ø 22 x h.42





Perduto  
è tutto il tempo  
che in amor  
non si spende.

*All the time  
is lost,  
that love  
does not spend.*



# Le Gemme

Sistema componibile notte  
*Modular system night*





101 - Composizione armadio 3 ante  
195 x 65 x 253



102 - Composizione armadio 4 ante  
255 x 65 x 253







103 - Composizione ad angolo 6 ante  
295+233 x 65 x 253







104 - Composizione ad angolo 5 ante  
256+195 x 65 x 253





105 - Composizione armadio 6 ante  
+ cassetti  
376 x 65 x 253



106 - Composizione armadio 6 ante  
+ cassetti + vano TV  
376 x 65 x 253





107 - Composizione armadio 6 ante  
376 x 65 x 253



# ABACO



115 Topazio - Comò  
 115 Topazio - Chest of drawers  
 122 x 54 x 105

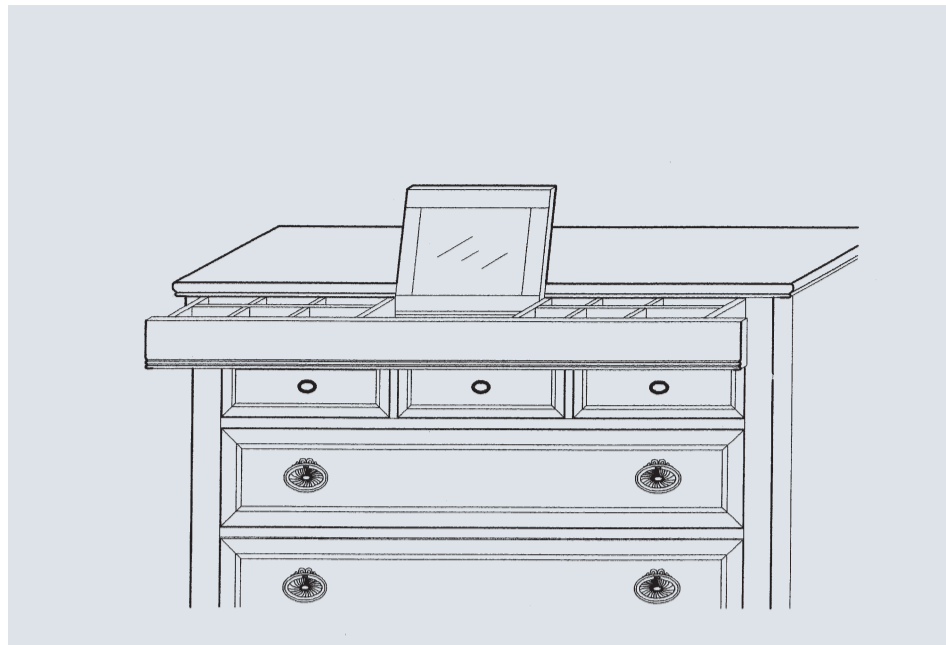

115 Acc - Accessorio per comò art.115  
 115 Acc - Accessory for chest of drawer art.115



112 Zaffiro - Comodino con cassetti  
 112 Zaffiro - Bedside table  
 54 x 35 x 66

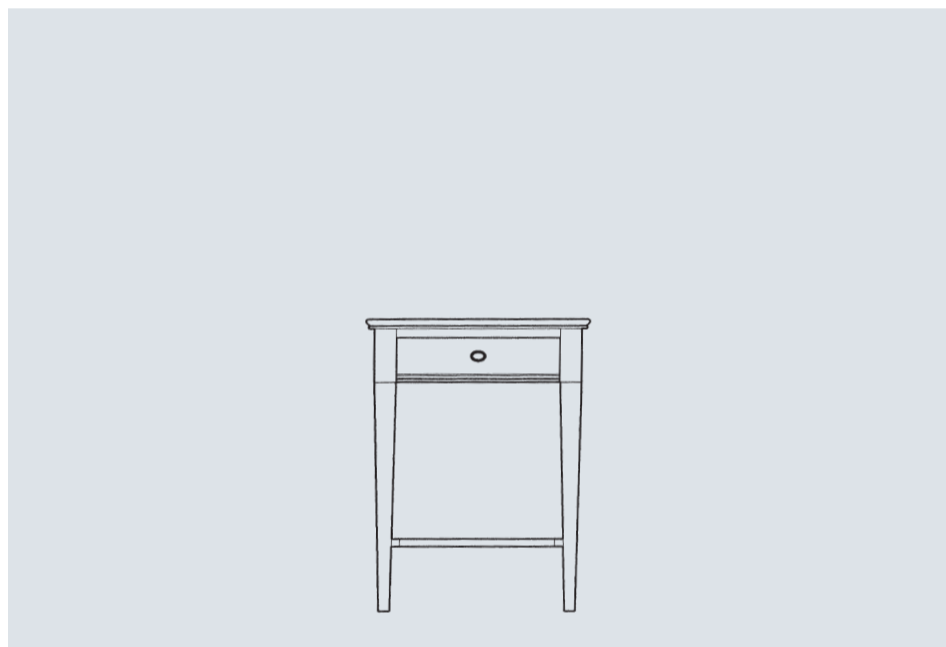

117 Zircone - Comodino a giorno  
 117 Zircone - Bedside table  
 52 x 36 x 68

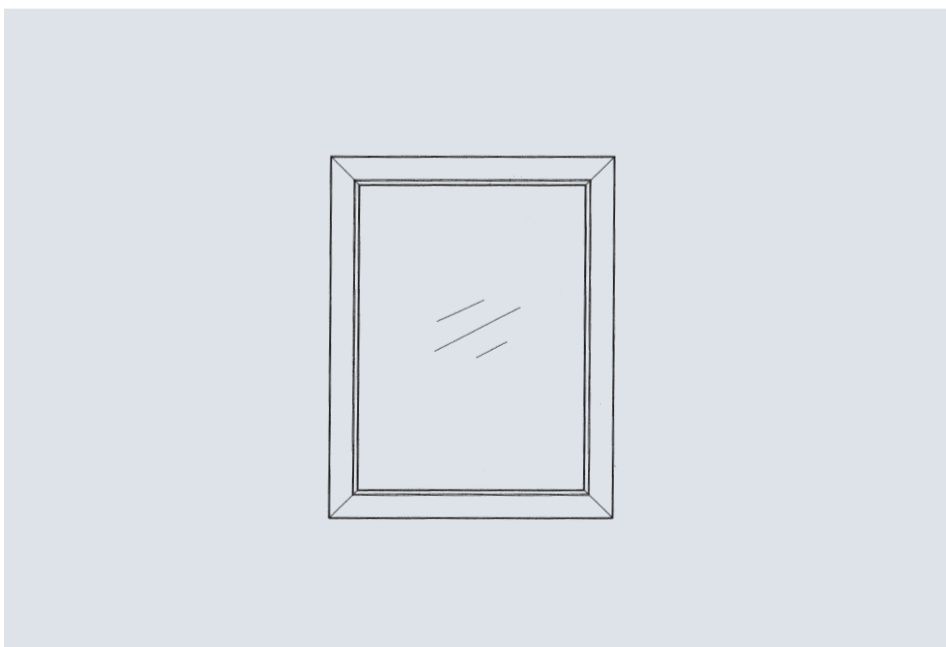

113 Ambra - Specchiera  
 113 Ambra - Mirror  
 72 x 3 x 92



163 Pavè - Specchio  
 163 Pavè - Mirror  
 121 x 3 x 121

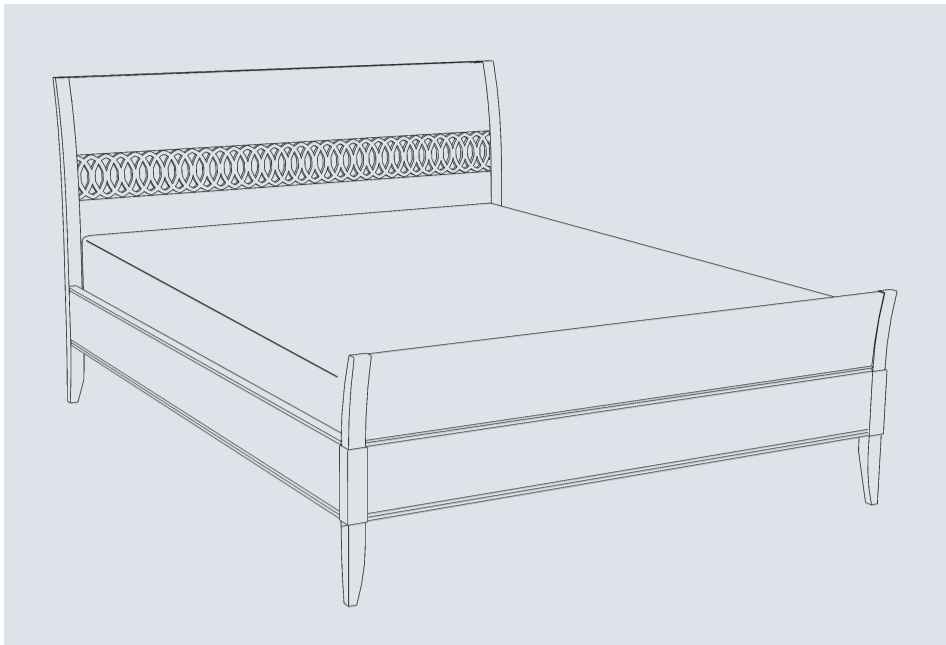

116 Corallo - Letto traforato  
116 Corallo - Fretworked bed  
168 x 220 x 109

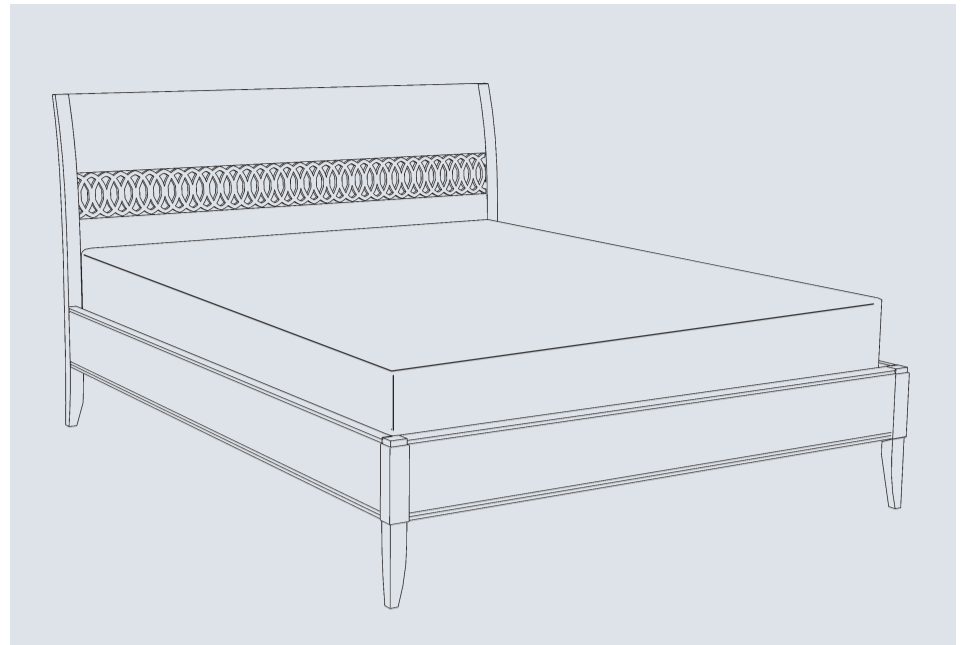

157 Corallo - Letto traforato a giroletto  
157 Corallo - Fretworked bed  
168 x 218 x 109

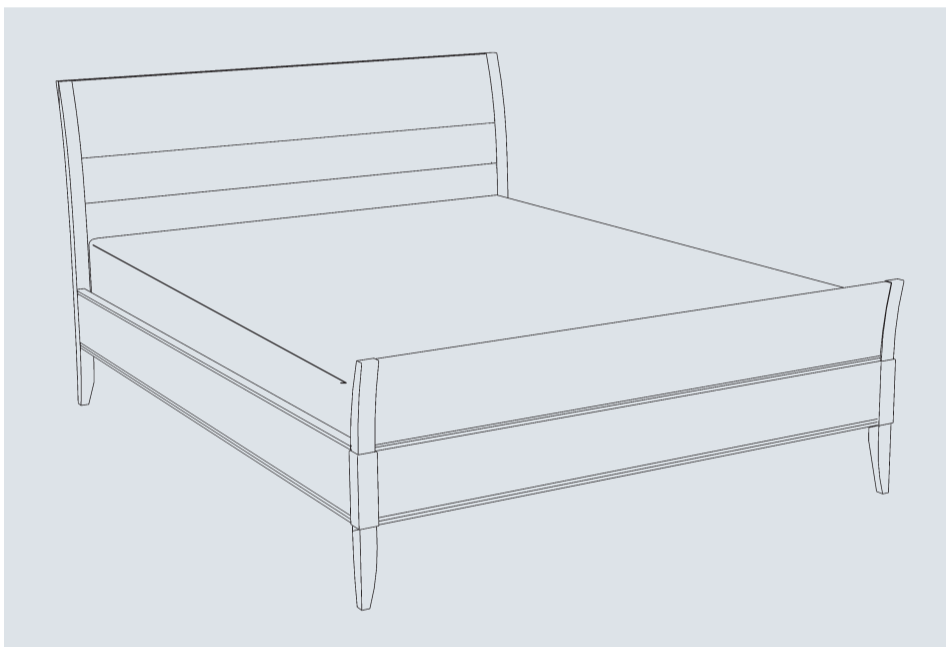

156 Granato - Letto con pelle  
156 Granato - Bed  
168 x 220 x 109

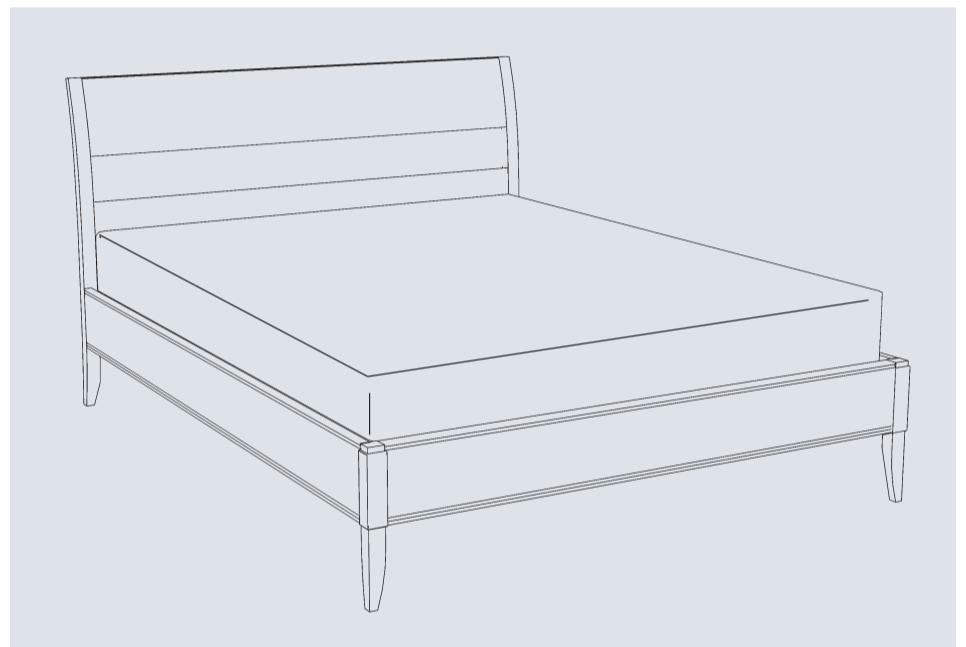

158 Granato - Letto con pelle a giroletto  
158 Granato - Bed  
168 x 218 x 109

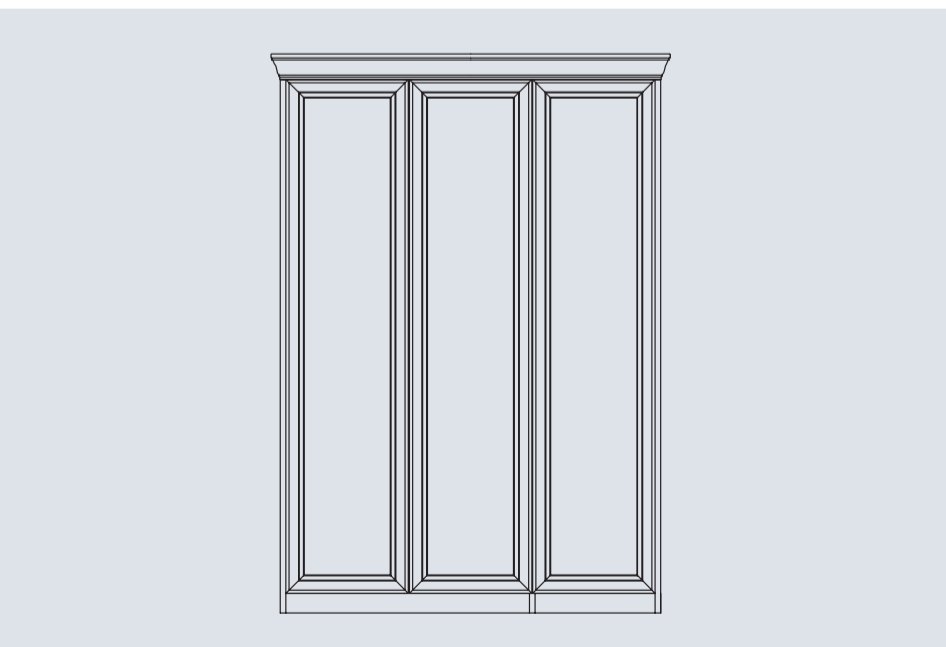

101 Composizione - Armadio 3 ante  
101 Composition - Wardrobe  
195 x 65 x 253

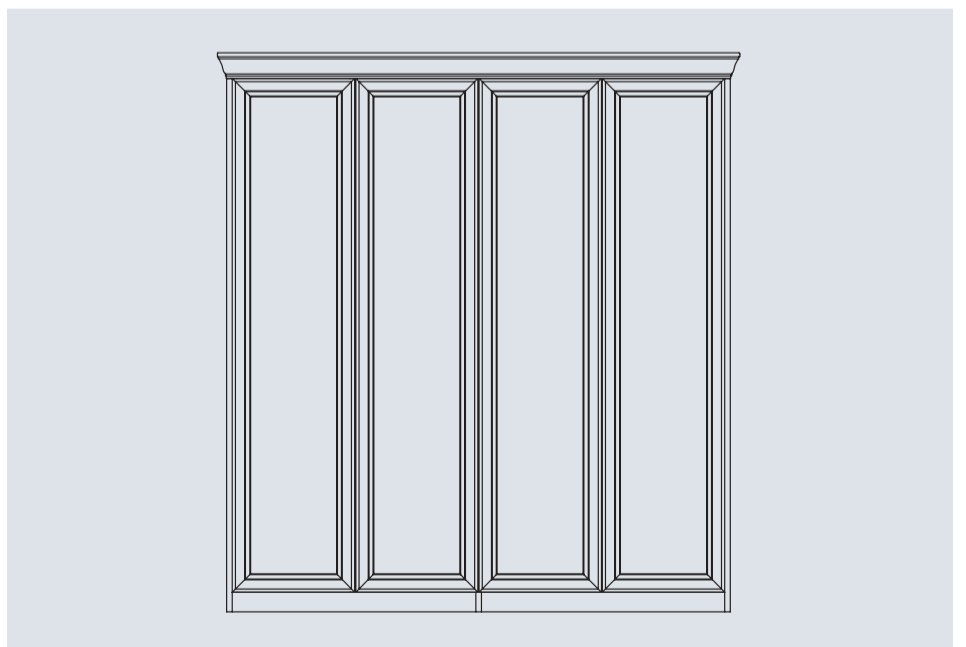

102 Composizione - Armadio 4 ante  
102 Composition - Wardrobe  
255 x 65 x 253

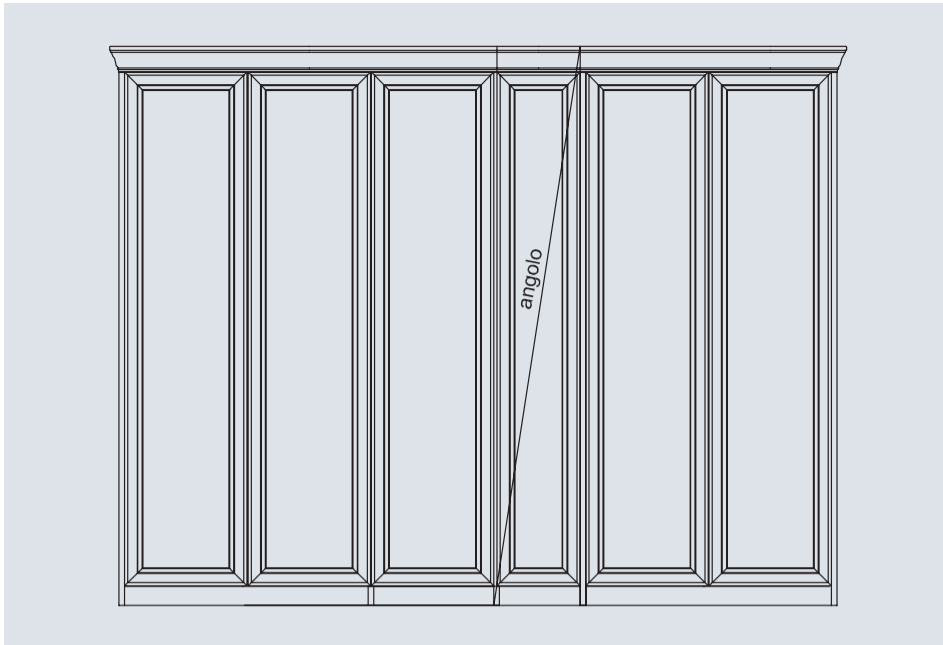

103 Composizione - Armadio ad angolo 6 ante  
 103 Composition - Wardrobe  
 295+233 x 65 x 253

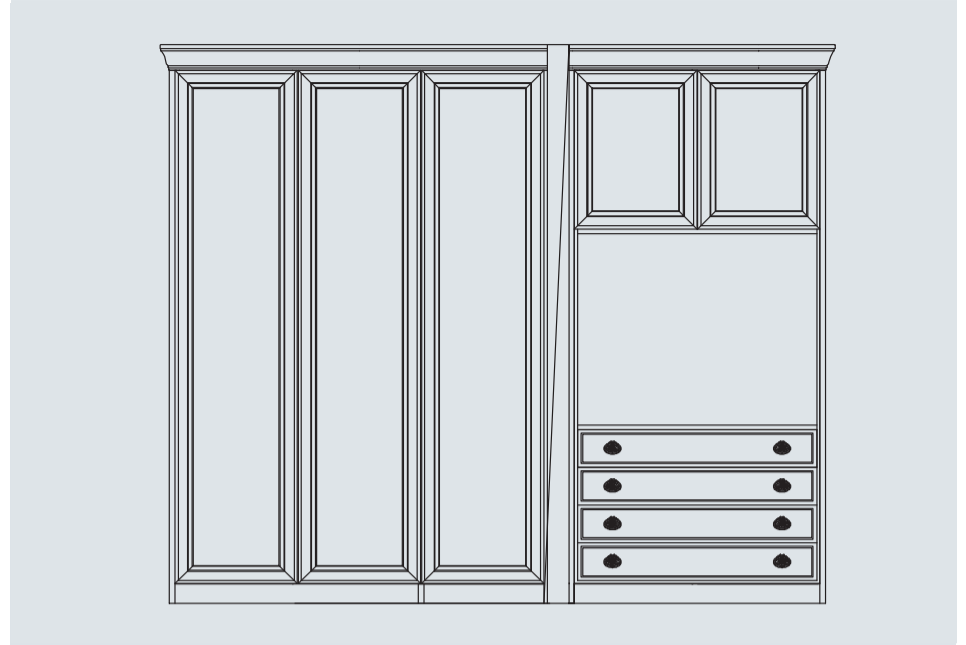

104 Composizione - Armadio ad angolo 5 ante  
 + cassetti + vano TV  
 104 Composition - Wardrobe  
 256+195 x 65 x 253

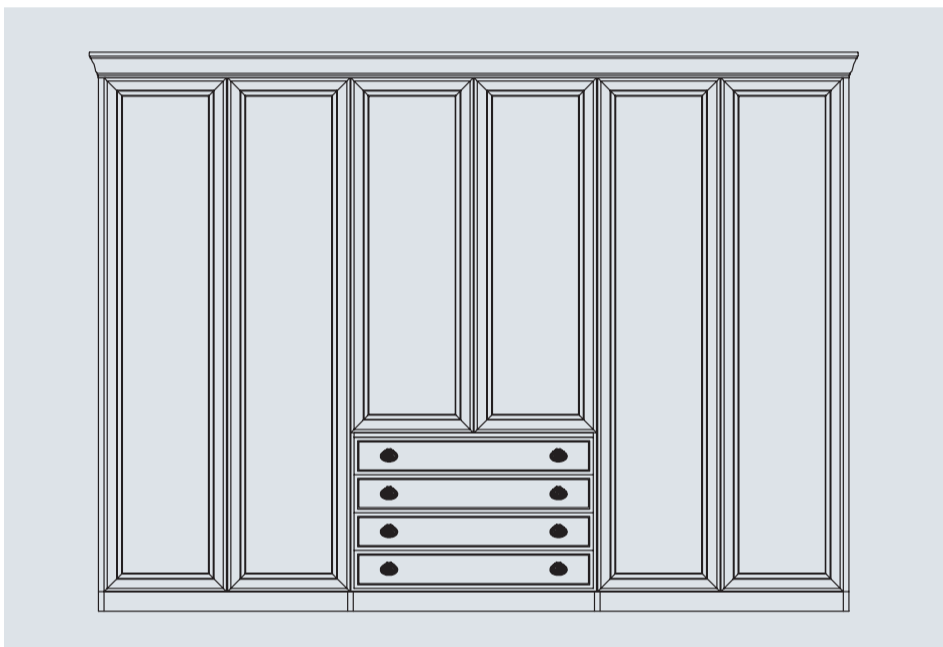

105 Composizione - Armadio 6 ante + cassetti  
 105 Composition - Wardrobe  
 376 x 65 x 253

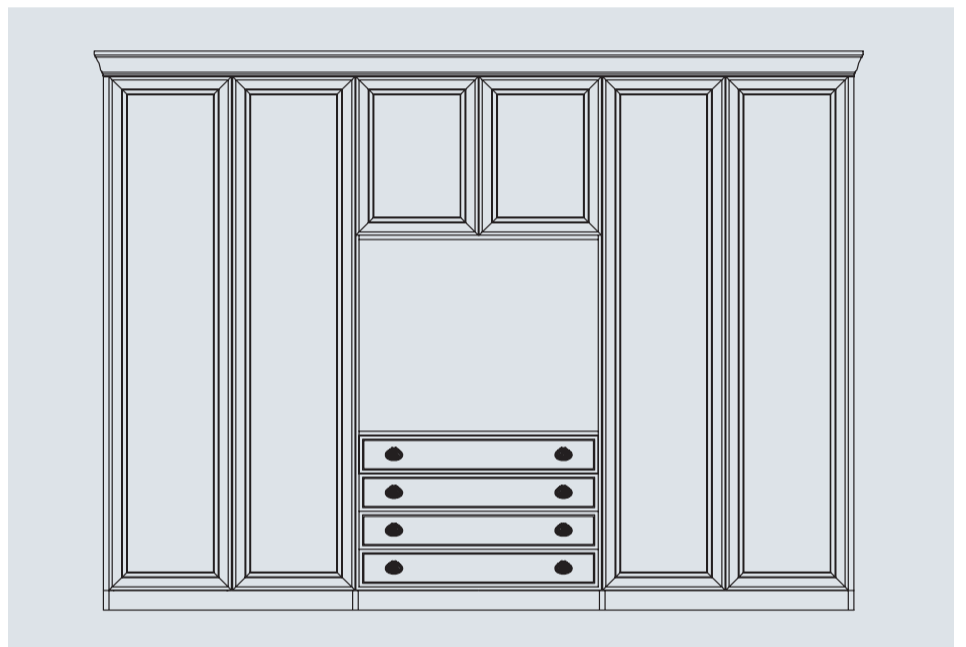

106 Composizione - Armadio 6 ante + cassetti + vano TV  
 106 Composition - Wardrobe  
 376 x 65 x 253

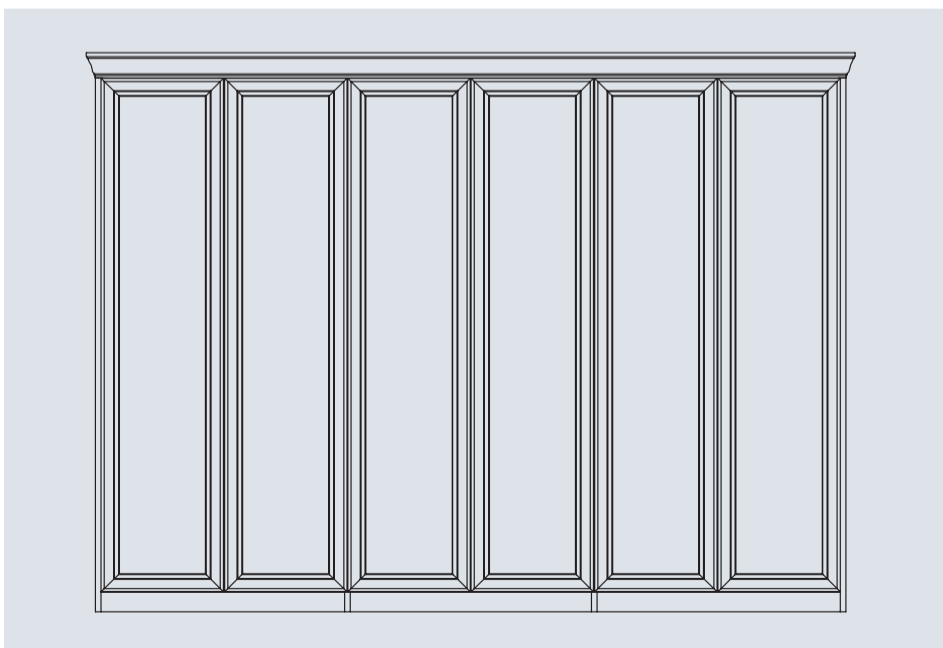

107 Composizione - Armadio 6 ante  
 107 Composition - Wardrobe  
 376 x 65 x 253





**Le Fablier SpA**  
via del Lavoro, 2  
37067 Valeggio sul Mincio - Verona  
tel +39 045 6372000

www.lefablier.com  
info@lefablier.it

**Le Gemme Notte**

design  
**Le Fablier S.p.A.**  
ufficio ricerca e sviluppo/  
R&D office

graphic design  
**Francesca Meneguzzi**

fotografia/  
photography  
**Mauro Negro**

assistenti alla fotografia/  
photography assistants  
**Marzio De Santis**

stylist  
**Marta Meda**  
in collaborazione con/  
*in collaboration with*  
**Monica Cresci**

coordinamento/  
coordination  
**Paola Storace**

stampa/  
print  
**OGM**

Grazie a/  
Thanks to

FEDON - [www.fedongroup.com](http://www.fedongroup.com)

La Redoute - [www.laredoute.it](http://www.laredoute.it)

Club Des Sports - [www.clubdessports.eu](http://www.clubdessports.eu)

PT01 Pantaloni Torino - [www.pt01.it](http://www.pt01.it)

Historic Research - [www.historic-research.it](http://www.historic-research.it)

Rimowa - [www.rimowa.de](http://www.rimowa.de)

Nava Design - [www.navadesign.com](http://www.navadesign.com)

Thinkashmir - [www.thinkashmir.com](http://www.thinkashmir.com)

Happidea - [www.happidea.it](http://www.happidea.it)

Lampade - *Luci e Forme Le Fablier (VR)*

3ª edizione – Ottobre 2010

Il catalogo è di proprietà esclusiva di Le Fablier S.p.A. - Tutti i diritti sono riservati. È vietata ogni forma di riproduzione anche parziale.

This catalogue is of exclusive property of Le Fablier S.p.A. – All right are reserved. Any form of total or partial reproduction of the catalogue is strictly forbidden.

Il marchio e il logo "Le Fablier – valori per sempre" sono depositati e registrati. The "Le Fablier – valori per sempre" brand and logo are filed and registered.

La stampa tipografica non sempre riproduce fedelmente le tinte degli originali. The printing process do not always permit a faithful reproduction of tones of originals.

Le Fablier si riserva la facoltà di apportare in qualsiasi momento modifiche tecniche e dimensionali ai modelli, anche senza preavviso.

Le Fablier reserves the right to change, in any time and without prior warning, the technical specifications and dimensions of the articles.